

Pins & IO

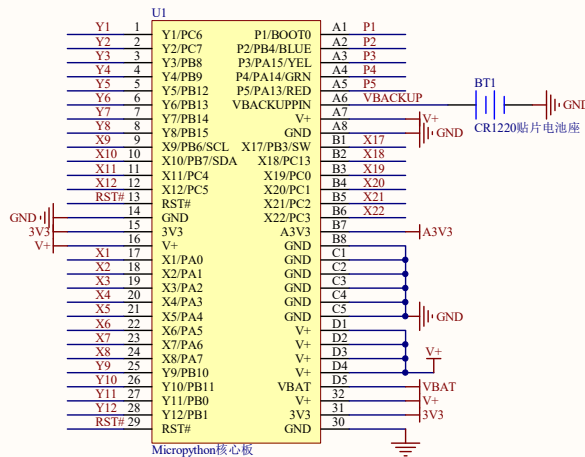

pyBoard Connect

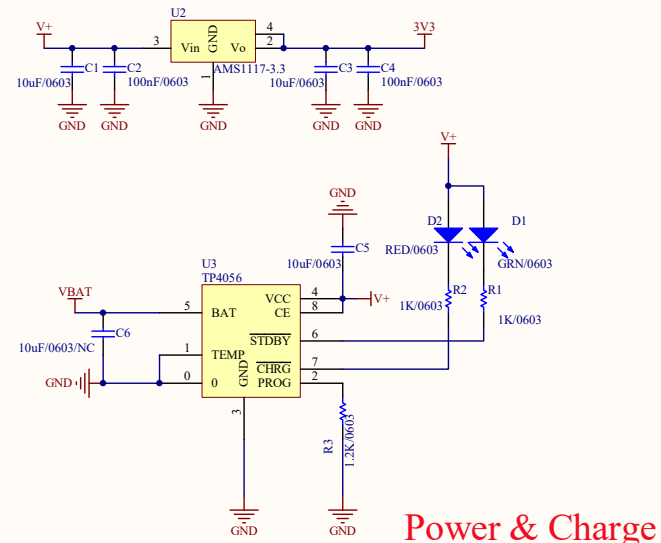

Power & Charge

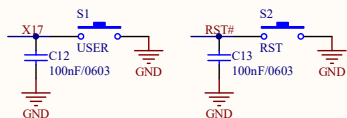

KEYS

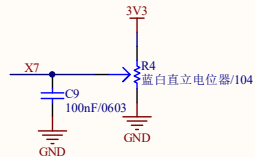

ADC

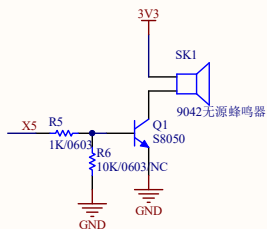

Beep (DAC)

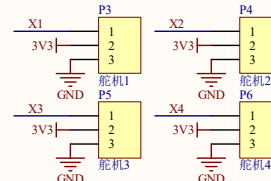

Servo

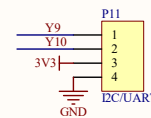

I2C/UART

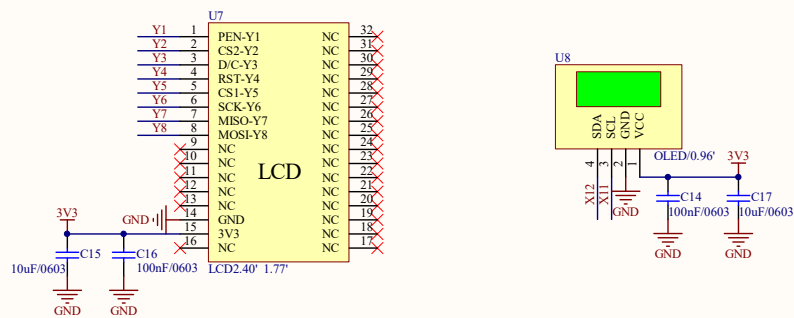

Display

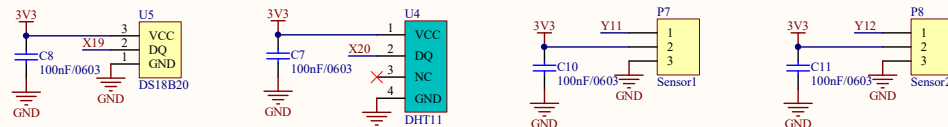

Sensors

Title			pyBase		
Size	Number	www.01Studio.org		Revision	v1.0
Date:	2019-05-21	Sheet of			
File:	D:\pyBase\SCHDOC	Drawn By:			